

33490/**/16



Gebruiksaanwijzing

Notice d'emploi

Benutzerhandbuch

User manual

Manual de usuario



PHILIPS

Incl.

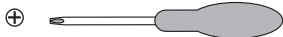
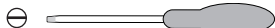
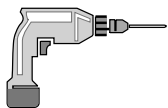
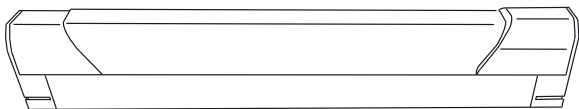

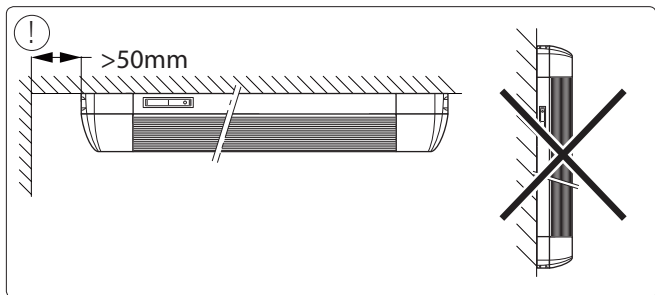
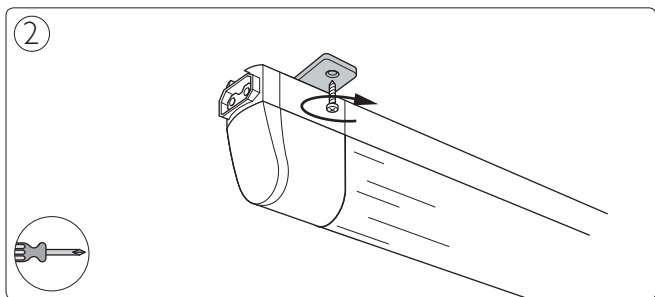
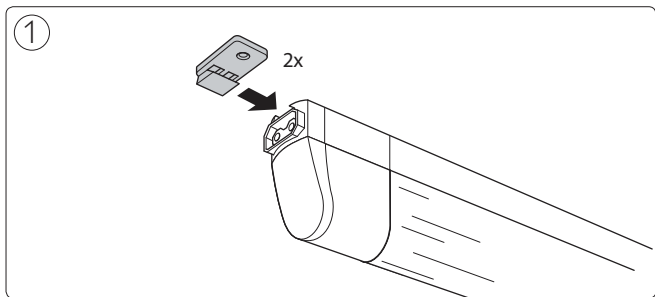

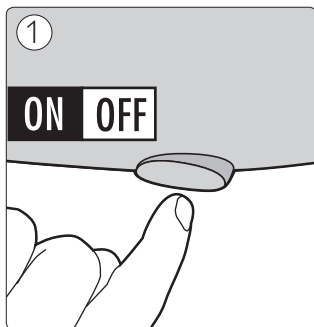
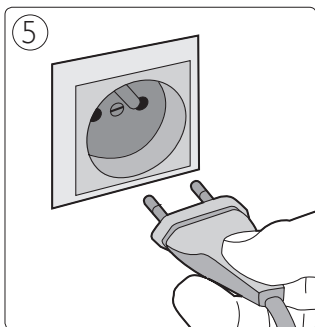
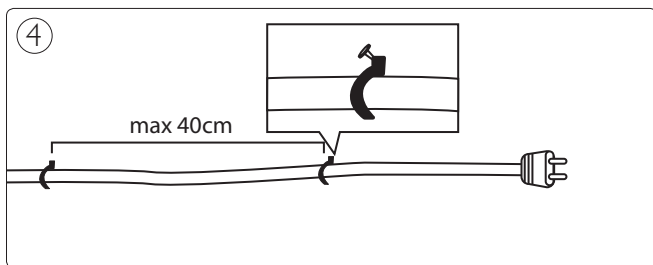
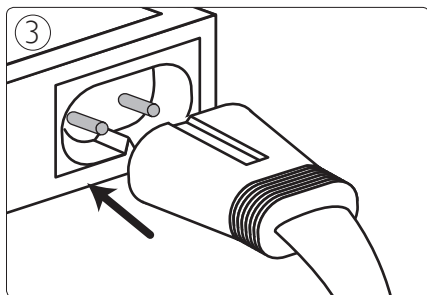

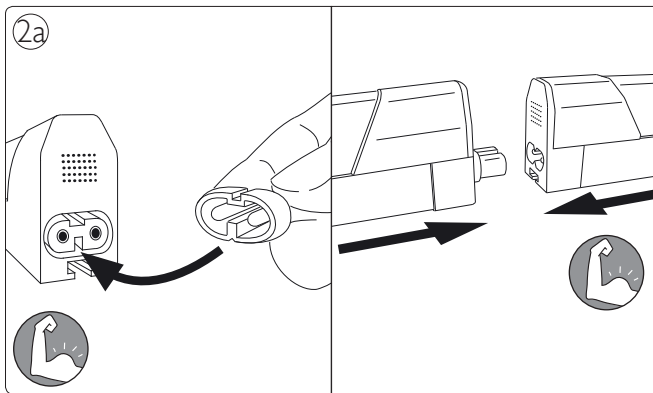
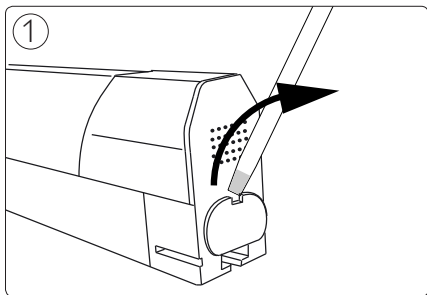
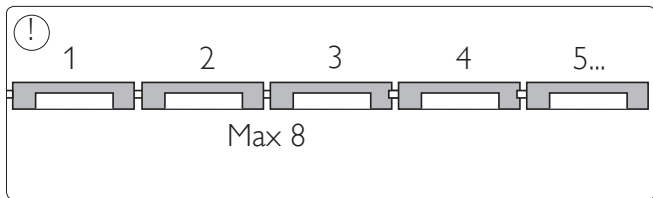

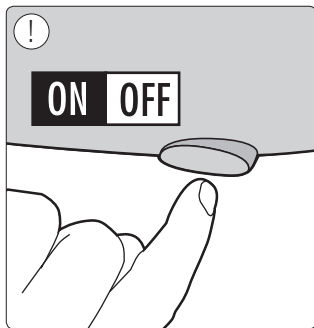
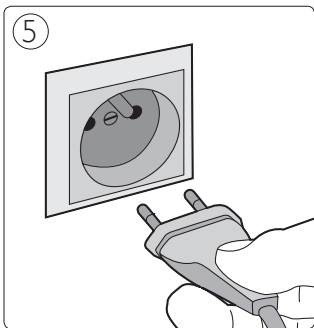
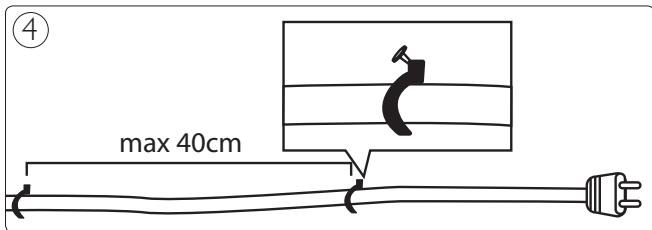
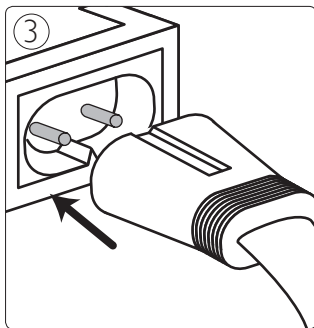
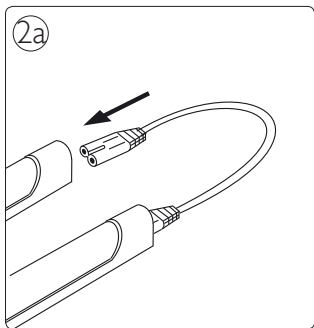

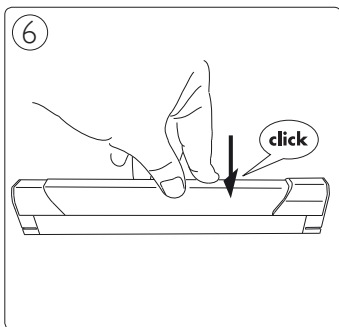
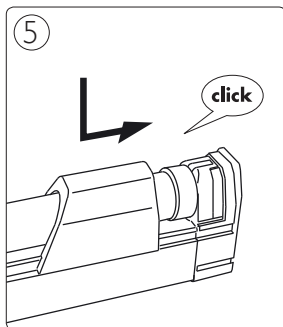
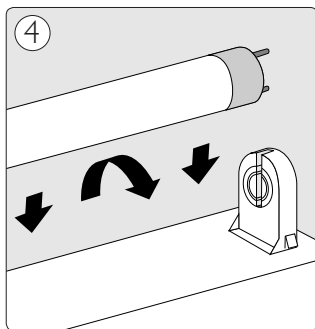
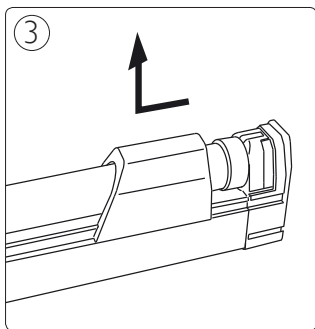
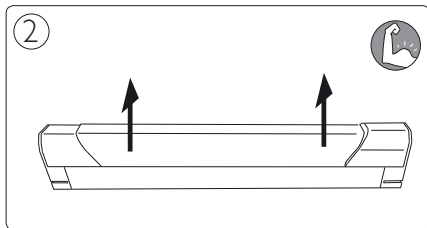
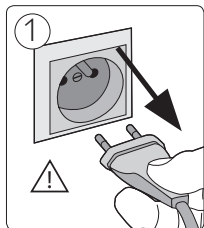



Philips Lighting Contact Centre
Int. Business Reply Service
I.B.R.S. / C.C.R.I. Numéro 10461
5600 VB Eindhoven
Pays-Bas / The Netherlands

www.philips.com/homelighting
 +800 7445 4775

4404.018.32931
Last update: 10/08/12